



T-29-11

2029A PNP Epitaxial Planar Silicon Transistor

Differential Amp Applications

©977C

Applications

- . Differential amp, current mirror.

Features

- . Excellent in thermal equilibrium and suited for use in first-stage differential amp.
- . Low noise.
- . Matched pair capability.

Absolute Maximum Ratings at Ta=25°C

| | | | unit |
|------------------------------|------------------|-------------|------|
| Collector to Base Voltage | V _{CB0} | -130 | V |
| Collector to Emitter Voltage | V _{CE0} | -120 | V |
| Emitter to Base Voltage | V _{EB0} | -5 | V |
| Collector Current | I _C | -50 | mA |
| Peak Collector Current | i _{cp} | -100 | mA |
| Collector Dissipation | P _C | 200 | mW |
| Total Dissipation | P _T | 400 | mW |
| Junction Temperature | T _J | 150 | °C |
| Storage Temperature | T _{stg} | -55 to +150 | °C |

1 unit

Electrical Characteristics at Ta=25°C

| | | | min | typ | max | unit |
|--------------------------|-------------------------------|--|------|------|------|------|
| Collector Cutoff Current | I _{CB0} | V _{CB} =-80V, I _E =0 | | | -0.1 | uA |
| Emitter Cutoff Current | I _{EB0} | V _{EB} =-4V, I _C =0 | | | -0.1 | uA |
| DC Current Gain | h _{FE} | V _{CE} =-6V, I _C =-1mA | 160* | | 560* | |
| DC Current Gain Ratio | h _{FE} (small/large) | V _{CE} =-6V, I _C =-1mA | 0.85 | 0.98 | | |

Continued on next page.

*:The 2SA1240 is classified by h_{FE} (small) as follows:

| | | | | | |
|-----|---|-----|-----|---|-----|
| 160 | F | 320 | 280 | G | 560 |
|-----|---|-----|-----|---|-----|

The 2SA1240 is provided with a surface mounted package.

Case Outline 2029A (unit:mm)

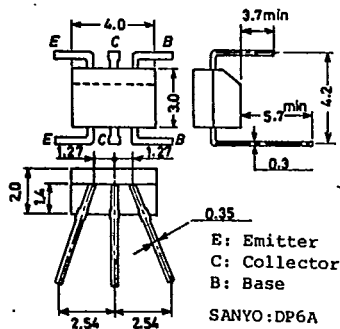

Case Outline 2030A (unit:mm)

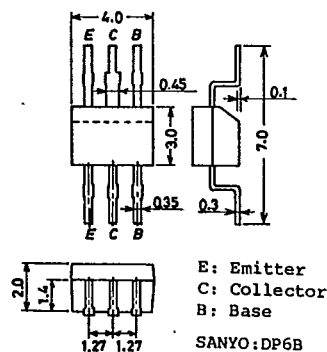

2SA1240

T-29-11

Continued from preceding page.

| | | | min | typ | max | unit |
|---|-----------------------|---|------|-----|------|------|
| Base to Emitter Voltage Drop | $V_{BE(large-small)}$ | $V_{CE}=-6V, I_C=-1mA$ | | 1.0 | 10 | mV |
| Collector to Emitter Saturation Voltage | $V_{CE(sat)}$ | $I_C=-10mA, I_B=-1mA$ | | | -0.5 | V |
| Gain-Bandwidth Product | f_T | $V_{CE}=-6V, I_C=-1mA$ | | 110 | | MHz |
| Output Capacitance | c_{ob} | $V_{CB}=-10V, f=1MHz$ | | 2.0 | | pF |
| Collector to Base Breakdown Voltage | $V_{(BR)CBO}$ | $I_C=-10\mu A, I_E=0$ | -130 | | | V |
| Collector to Emitter Breakdown Voltage | $V_{(BR)CEO}$ | $I_C=-1mA, R_{BE}=\infty$ | -120 | | | V |
| Emitter to Base Breakdown Voltage | $V_{(BR)EBO}$ | $I_E=-10\mu A, I_C=0$ | -5 | | | V |
| Noise Level | $V_{NO(ave)}$ | $V_{CC}=30V, I_C=1mA, R_g=56k\Omega, V_G=77dB/1kHz$ | | | 35 | mV |
| Noise Peak Level | $V_{NO(peak)}$ | $V_{CC}=30V, I_C=1mA, R_g=56k\Omega, V_G=77dB/1kHz$ | | | 200 | mV |

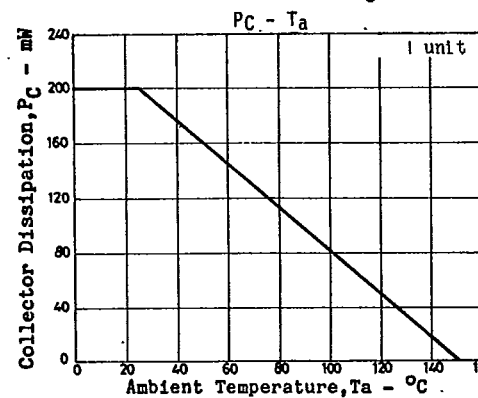
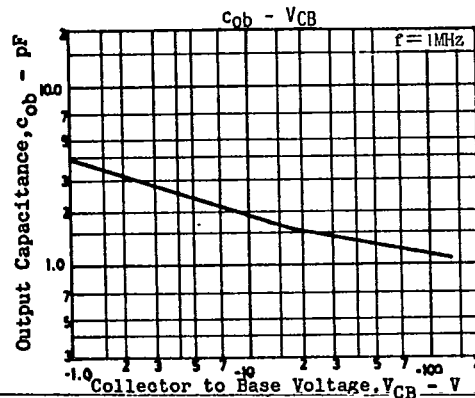
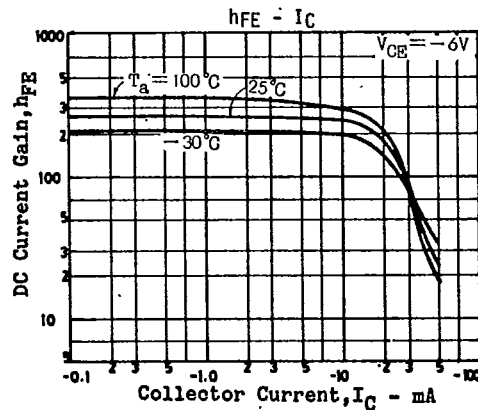
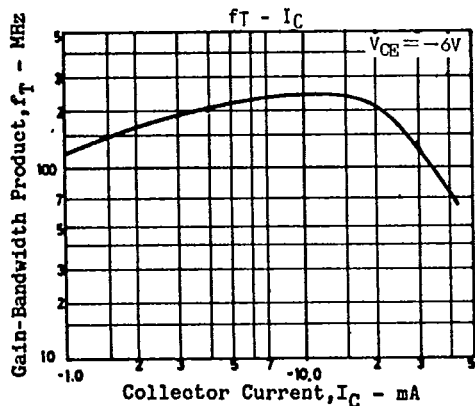
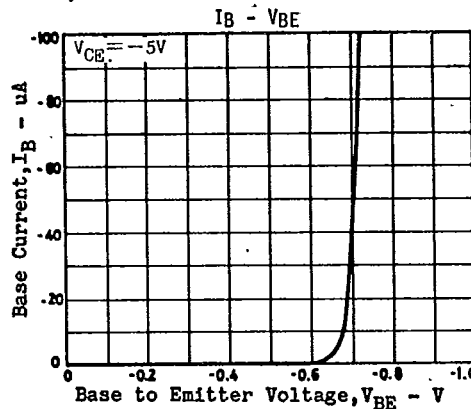
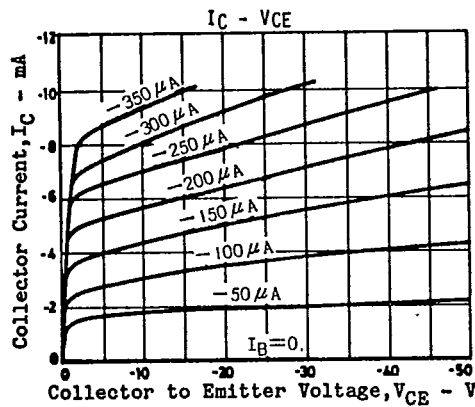

T-29-11

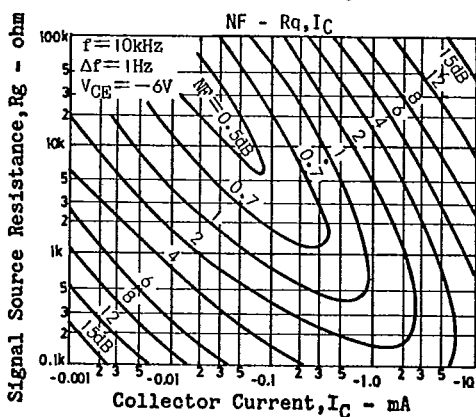
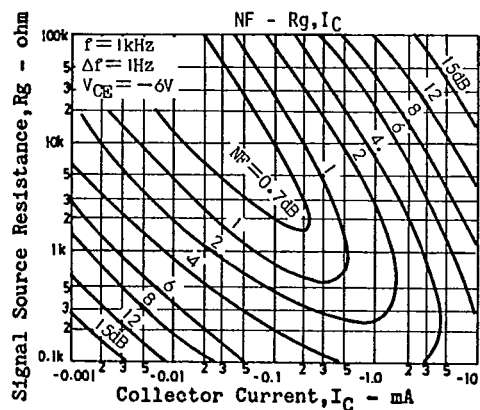
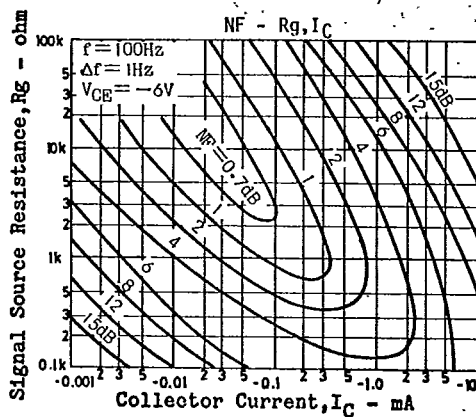
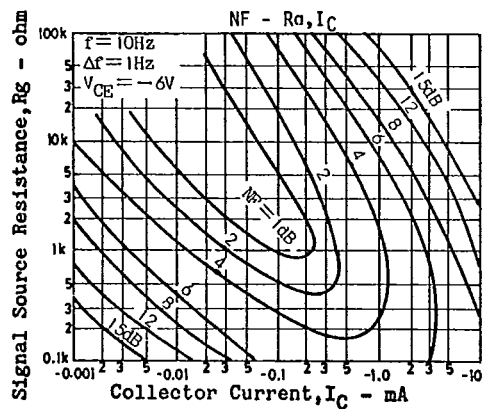

T-91-20

CASE OUTLINES OF LEAD FORMED SMALL SIGNAL TRANSISTORS

- All of Sanyo lead formed small signal transistor case outlines are illustrated below.
- All dimensions are in mm, and dimensions which are not followed by min. or max. are represented by typical values.
- No marking is indicated.

Case Outline-[2003A] unit: mm

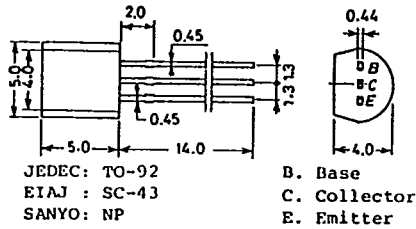

Case Outline-[2019A] unit: mm

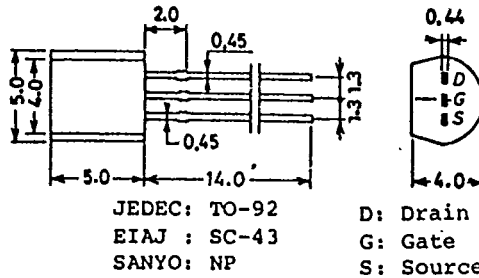

Case Outline-[2004A] unit: mm

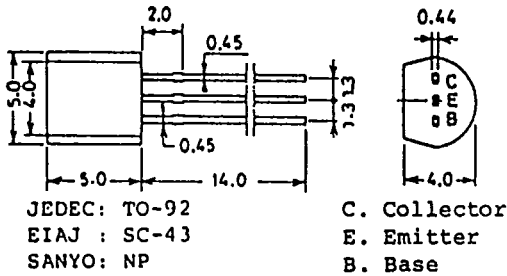

Case Outline-[2025] unit: mm

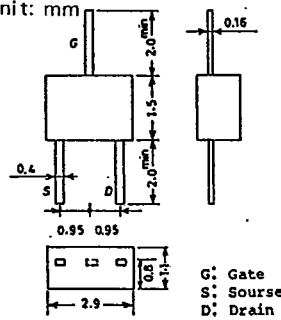

Case Outline-[2005A] unit: mm

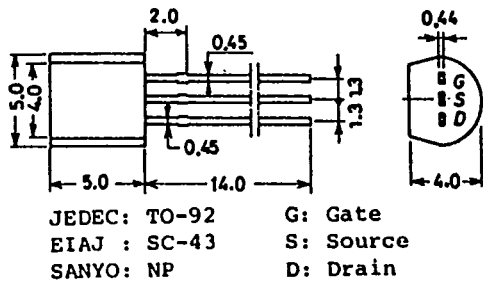

Case Outline-[2026] unit: mm

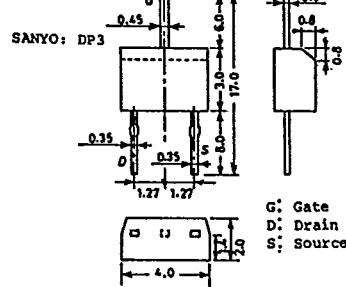

Case Outline-[2006A] unit: mm

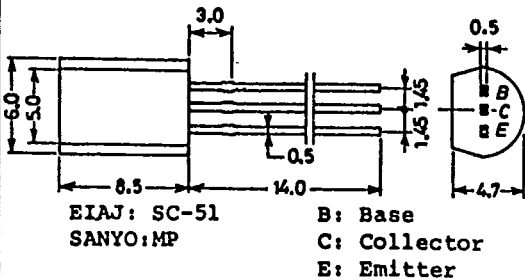

Case Outline-[2027A] unit: mm

